

# USA North's Nevada Excavation Manual

# 811 / 1-800-227-2600



Know what's below.  
Call before you dig.

- Overview: Page 1-6.
- Ticket Format: Page 6-7.
- Five Steps to a Safe Excavation: Page 7-8.
- No Response Follow-up Message: Page 8-9.
- Damage and Emergency Notification: Page 9.
- Suggested Marking Guidelines: Page 10-21.

**Disclaimer Notice:** The suggested guidelines contained in this booklet are not intended to prevent excavators or operators from providing alternate forms of marking that are in accordance with Nevada Revised Statutes 455.080 – 455.180. The suggested guidelines are representative in nature and do not address all delineation or facility markout situations.

**NOTE: The Following Bullets are Nevada Revised Statute 455 and Nevada Administrative Code 455**

- **Nevada Revised Statutes (NRS) 455.080 – 455.180 Requirements:** Page 21-28.
  - Outline your excavation area in white [455.110 (1) (b) (2)] Page 23.
  - A 2 working day up to 14 calendar day (legal) notice is required before digging [455.110 (1) (a)] Page 23.
  - USA North will notify its members of your excavation [455.084] Page 21.
  - The USA North members will by the legal notice mark or stake the horizontal path of their facilities, provide information about the location of their facilities, or advise of clearance [455.130 (1) (a) (c), & (2)] Page 25.
  - Expose the underground facilities by hand before using power equipment [455.137 (1)] Page 26.
- **Nevada Administrative Code (NAC) 455.010 - 455.165 Requirements:** Page 29-40.
  - The USA North ticket number is valid for 28 calendar days. You must have an active USA North ticket number for the entire duration of your excavation [455.165 (1)] Page 39.

**This manual is provided to you as a public service by USA North and is dedicated to the safety of our communities in California and Nevada.**

**Know what's below.**

**Call 2 Working Days To 14 Calendar Days  
Before You Dig in California and Nevada!**



## OVERVIEW

USA North provides a free and effective Damage Prevention Service that protects our citizens, our communities, our environment, our essential public services, and our underground facilities in Central / Northern California and all of Nevada. USA North began operation in May of 1975 and incorporated as a Non Profit Mutual Benefit Corporation in 1986. Our purpose is to receive planned excavation reports that will begin within the next 14 calendar days from homeowners, excavators, or professional contractors and transmit those planned excavation reports to all participating members of USA North who may have facilities at that excavation site. Our members will 1) mark or stake the horizontal path of their facility, 2) provide information about the location of their facility, or 3) advise the caller of clearance, for facilities that they own.

### **USA North's Service Area:**

**Central & Northern California:** Alameda, Alpine, Amador, Butte, Calaveras, Colusa, Contra Costa, Del Norte, El Dorado, Fresno, Glenn, Humboldt, Kern, Kings, Lake, Lassen, Madera, Marin, Mariposa, Mendocino, Merced, Modoc, Mono, Monterey, Napa, Nevada, Placer, Plumas, Sacramento, San Benito, San Francisco, San Joaquin, San Luis Obispo, San Mateo, Santa Clara, Santa Cruz, Shasta, Sierra, Siskiyou, Solano, Sonoma, Stanislaus, Sutter, Tehama, Trinity, Tulare, Tuolumne, Yolo and Yuba.

**Nevada:** Carson City, Churchill, Clark, Douglas, Elko, Esmeralda, Eureka, Humboldt, Lander, Lincoln, Lyon, Mineral, Nye, Pershing, Storey, Washoe, and White Pine.

### **Common Ground - Study of One-Call Systems and Damage Prevention Best Practices:**

The United States Department of Transportation's Office of Pipeline Safety (OPS) initiated the Common Ground report under the authorization of the Transportation Equity Act for the 21<sup>st</sup> Century (TEA 21), Public Law 105-178, signed into law on June 9, 1998. The purpose of the study was to identify and validate existing best practices performed in connection with preventing damages to underground facilities. The Study ultimately resulted in a quality product that can be used to help in future efforts to improve underground damage prevention. The collected best practices should be shared among stakeholders involved with and dependent upon the safe and reliable operation, maintenance, construction, and protection of underground facilities.

### **Common Ground Chapters Titles:**

1. Introduction Practice Statements
2. Planning & Design Best Practices
3. One-Call Center Best Practices
4. Locating & Marking Best Practices

5. Excavation Best Practices
6. Mapping Best Practices
7. Compliance Best Practices
8. Public Education & Awareness Best Practices
9. Reporting & Evaluation Best Practices
10. Appendix A - Glossary of Terms & Definitions
11. Appendix B - Uniform Color Code & Marking Guideline
12. Appendix C - Sample Form for Reporting Damage Prevention Information
13. Appendix D - Additional References

For a complete version of the Common Ground Alliance Best Practices logon to [www.commongroundalliance.com](http://www.commongroundalliance.com) and download this information or order a copy.

### **Common Ground Alliance Chapter 5 “Excavation Best Practices”:**

1. One-Call Facility Location Request
2. White Lining (CA & NV requires that you mark in white)
3. Locate Reference Number
4. Pre-excavation meetings
5. Facility Relocations
6. Separate Location Requests
7. One-Call Access (24x7)
8. Positive Response
9. Facility Owner / Operator Failure to Respond
10. Locate Verification
11. Documentation of Marks
12. Work Site Review with Company Personnel
13. One-Call Reference Number at Site
14. Contact Names and Numbers
15. Facility Avoidance
16. Federal and State Regulations
17. Marking Preservation
18. Excavation Observer
19. Excavation Tolerance Zone
20. Excavation within the Tolerance Zone
21. Mis-Marked Facilities
22. Exposed Facility Protection
23. Locate Request Updates
24. Facility Damage Notification
25. Notification of Emergency Personnel
26. Emergency Excavation
27. Backfilling
28. As-Built Documentation
29. Trenchless Excavation
30. Emergency Coordination with Adjacent Facilities

### **Important Web Sites:**

- ◆ Common Ground Alliance / One Call Systems Int'l  
[www.commongroundalliance.com](http://www.commongroundalliance.com)
- ◆ USA North – (Call Before You Dig Center)  
[www.usanorth.org](http://www.usanorth.org)

- ◆ California Government Code [www.leginfo.ca.gov/cgi-bin/calawquery?codesection=gov&codebody=4216&hits=20](http://www.leginfo.ca.gov/cgi-bin/calawquery?codesection=gov&codebody=4216&hits=20)
- ◆ California Code of Regulations (Cal/OSHA) - [www.dir.ca.gov/title8/1541.html](http://www.dir.ca.gov/title8/1541.html)
- ◆ Nevada Revised Statutes - [www.leg.state.nv.us/NRS/NRS-455.html](http://www.leg.state.nv.us/NRS/NRS-455.html)
- ◆ Nevada Administration Code - [www.leg.state.nv.us/NAC/NAC-455.html](http://www.leg.state.nv.us/NAC/NAC-455.html)

**Be knowledgeable of all Federal, State, County, City, or Local Requirements:**

- Construction Code
- Contractor License Code
- Safety Code
- Franchise Code
- OSHA
- County, City or Local Ordinances
- Others that apply

**General Excavation Information:**

- Prior to starting an excavation, examine the excavation site for physical evidence (manholes, valve covers, water meters, sewer cleanouts, vaults, utility maintenance boxes, pole risers, etc) that would indicate the existence of underground facilities. Always excavate, as cautiously and prudently as possible.
- USA North accepts calls for excavation work on public or private property, on Military Bases, on Indigenous People's Reservations and even on waterways within our coverage area.
- Our members will mark or stake the horizontal path, provide information about the location, or provide clearance for facilities that they own. Excavators should be aware there could be other facilities of the same type at the excavation site owned by the property owner or another company who is not a member of USA North.
- When excavating within 10' of subsurface installations daylight the facility by hand every 25' to make sure the facility is where it is indicated. When excavating in CA or NV within 24" of a facility the law requires you to hand expose and protect the facility (it does not mean daylight or pothole) prior to using power equipment.
- Individuals with first hand knowledge of the excavation site and that can be reached by telephone should call the location description into USA North. This allows us, and our members, to discuss the location with a person who has knowledge of the excavation layout and specific location.
- Limit your excavation location description to a site that can be completed within a 28 calendar day period from

the date of your call to USA North in California or Nevada and that our members can reasonably locate within 2 working days.

- USA North limits excavation work to areas no longer in length than 1½ miles in a metropolitan area and 3 miles in a rural area.
- Dividing larger excavation areas into smaller manageable sites helps our members respond to your excavation site more promptly.
- As work in one excavation site nears completion, call in your next excavation site to USA North and continue this process until your entire excavation area is complete.
- When working on private property the excavator should determine what facilities belong to the property owner; (water, well, sewer, septic tanks, gas, propane lines, electrical, etc.) and what easement(s) may exist on the property, if any. In general, ownership of underground facilities transfers to the property owner behind the curb, behind the sidewalk, clean out, at the meter or point of demarcation.
- USA North notifies only its members of your excavation work, for your safety you should notify any non-member.

### **Excavation Types:**

**Special Note** - You will need to provide the City or Community that the excavation work is being done in and a verbal description of your excavation site. From your description, your Digsite will be built on the USA North base map to determine which of our members will be notified for that area. If your information is not accurate and correct the wrong members could be notified. It is critical that you provide USA North precise information about the location of the excavation, this is especially true when dealing with; New Streets, New Subdivisions or work off the roadway. If you are using distance or direction measurements, you should be accurate within 10 feet + or - with each measurement. To insure the accuracy of your location, provide the Latitude Longitude positions from a GPS device using NAD 83 CONUS decimal format.

#### I. Street/Address:

A. For an address provide:

- 1) Address and street name.
- 2) Two nearest streets that the address is between (system can take one street).
- 3) Where on the property you are digging?
- 4) How many feet from the street in front of your address is the work?

B. For multiple addresses provide:

- 1) Addresses and street name.
- 2) Two nearest streets that these addresses are between (system can take one street).
- 3) Where on the property you are digging?

- 4) How many feet from the street in front of your address is the work?

C. For a Street provide:

- 1) Street name and nearest intersecting street
- 2) Side of street with distance / direction

II. Intersections:

A. For an Intersection provide:

- 1) Street name and intersecting Street name.
- 2) Where in the intersection you are working?

B. For work at a single point from the Intersection provide:

- 1) Street name and intersecting street name.
- 2) Distance / direction to the point where the work will be.

C. For multiple points from an intersection (you may have to divide your excavation site into multiple locations that fit into four lines of text) provide:

- 1) Street name and intersecting street name.
- 2) Distance / direction to the first point where the work will be at;
- 3) From the first point provide the distance / direction to the second point where the work will be at;
- 4) From the second point provide the distance / direction to the third point where the work will be at;
- 5) From the third point provide the distance / direction to the fourth point where the work will be at.

D. For continuous work from an intersection provide (you may have to divide your excavation site into multiple locations that fit into four lines of text):

- 1) Street name and intersecting street name.
- 2) Distance / direction to the first point where you will be working to;
- 3) From the first point provide the distance / direction to the second point where you will be working to;
- 4) From the second point provide the distance / direction to the third point where you will be working to;
- 5) From the third point provide the distance / direction to the fourth point where you will be working to.

III. Between Intersections:

A. For work on a Street between intersections provide:

- 1) Street name.
- 2) Two intersecting Street names that the work is between.
- 3) Description of where on the Street you are working with distance / direction.

B. Multiple points on a Street between intersections provide:

- 1) Street name.
- 2) Two nearest Street names that the work is between.
- 3) Description of where on the Street you are working with distance / direction for each point.

C. For New Streets or New Subdivision (containing no streets on map within the excavation area) provide:

- 1) Street and nearest intersection outside the excavation.
- 2) Distance / direction to the new Street or Subdivision and a radius they are contained within.

IV. Bounded by Areas (containing no streets on map within the excavation area):

A. For Bounded Areas with Streets provide:

- 1) Street names that bound the area (2, 3 or 4 streets).

B. For Bounded Areas with streets and distances provide:

- 1) Street names that will be used as boundaries for the area.
- 2) Distance / direction from the one or two streets that will create the bounded in area.

---

### **USA North Ticket Format:**

- ✓ Business Phone Number:
- ✓ Fax Number:
- ✓ Email Address:
- ✓ Your Name:
- ✓ Your Company Name:
- ✓ Type:
- ✓ Industry:
- ✓ Company's Address:
- ✓ City:
- ✓ State:
- ✓ Zip:
- ✓ What County is your work being done in?
- ✓ Start Date: (a 2 working day to 14 calendar day notice is required)
- ✓ Start Time:
- ✓ Working For:
- ✓ As required has site been Premarked?
- ✓ Premarked method used?
- ✓ Permit Type:                      Permit #:
- ✓ Forman's Name:
- ✓ Cell Telephone:                      Field Telephone:
- ✓ Does your excavation include boring, if so what type?
- ✓ Type/Nature of Work: (augering, drilling, grading, ripping, trenching, etc.)

- ✓ Will Explosives be used at your work site?
- ✓ Do you intend to use vacuum equipment instead of hand digging to determine the exact location of our member's underground facilities?
- ✓ Digsite Place: (City or Community)
- ✓ Digsite Types: Address(s) between 2 nearest Sts, Street between 2 nearest Sts, Street & nearest St, Intersection or Bounded by Area that contains no Streets;(include side of street, footages, other tie in measurements, or lat/long in NAD 83 CONUS decimal format).
- ✓ Will the excavation enter into the street or sidewalk area?
- ✓ Ticket #:
- ✓ Date of Call:
- ✓ Ticket Expiration Date:
- ✓ Update your ticket by:

Calling hours are from 6am-7pm Monday - Friday excluding weekends and the following holidays: New Year's Day, President's Day, Memorial Day, Independence Day, Labor Day, Thanksgiving Day, Day after Thanksgiving, and Christmas. USA North takes excavation notices in Central / Northern California and all of Nevada. Each ticket is active for 28 calendar days in California and Nevada from the date of its issuance. If you excavate and damage facilities prior to our member's response, you may be liable for those damages. After our members have responded to your request, it is your responsibility to notify USA North if you need our member(s) to re-mark their facilities. To minimize graffiti we recommend the use of spray chalk, water base, or UV paint by excavators and operators to identify their excavation site or subsurface installations respectively.

---

### **Five Steps to a Safe Excavation:**

1. **Survey and Mark:** Survey your proposed excavation site. Make a list of affected operators of underground facilities (operators) at your job site, their needs and requirements. Mark the excavation site on paved surfaces with white spray chalk, water base, UV paint or equivalent less permanent type marking; use flags, stakes, whiskers, etc. on unpaved surfaces, (Homeowners can use flour).

2. **Call Before You Dig:** Call USA North 2 working days to 14 calendar days (legal notice) before you dig in California or Nevada. Only operators who are members of the USA North program will be notified. Compare your list of affected operators determined in Step 1, with the list of operators notified by USA North. For your safety contact any operator at your job site that is not a member of USA North. USA North accepts design inquiry requests through its internet application only, call 925-798-9504 ext 2309 for more information.

3. **Wait the Required Time:** The legal 2 working days to 14 calendar days notice in California and Nevada allows USA North members to examine their underground facility records and respond to you. Our members, who are operators of underground facilities, will mark, or stake the horizontal path of their facility with the appropriate color code, provide you information about the location of their facility, or advise you of clearance. Depending on our member's workload, they may contact you to try to negotiate a new start time for your excavation. This will allow them the opportunity to provide you with greater service.

4. **Respect the Marks:** Preserve facility marks for the duration of the job. If any of the operator markings are not reasonably visible, you must call USA North and request re-marking by the affected operator(s). A re-mark request requires a 2 working day notice. When you request an operator(s) to re-mark their facilities, you will be asked if your excavation site is still outlined in white, so the USA North members can respond to your request.

Note: A USA North ticket is active for 28 calendar days in California and Nevada from the date of its issuance. You must have an active USA North ticket for the entire duration of your excavation.

5. **Dig With Care:** In California and Nevada hand excavate within 24" of the outside diameter of the facility. Facilities that are in conflict with your excavation are to be located with hand tools and protected before power equipment is used. Notify the affected utility of any contact, scrape, dent, nick or damage to their facility.

---

### **No Response Follow-Up:**

This process starts when the excavator notifies USA North that:

- A 2 working day to 14 calendar day (legal) notice was provided on the original ticket and,
- The start date/time has past and,
- A member(s) failed to respond to the excavation site by the legal start date & time of the ticket.

When a member successfully negotiates a new start date/time with an excavator, the negotiated start date/time becomes the legal start date/time for that excavation notice.

Once the start date/time has past, the excavator should determine if all USA North members have responded. The members will: mark or stake the horizontal path of their facilities, provide information about the location of their facilities, or advise of clearance. If the excavator determines that a member(s) of USA North has failed to respond in one of these manners the following steps are to be taken.

1) **First No Response Follow-up:** Call USA North after the original or agreed upon legal start date/time, that the work was to begin, and request USA North to send a

“First No Response Follow-up” to the member(s) (name the particular member(s)) that failed to respond to your notice. Request the member(s) to call and respond ASAP or call and provide clearance.

**2) Second No Response Follow-up:** Wait at least an hour or more, from your last call, to provide our member(s) an opportunity to call and respond to your first request. After this time has past and the member(s) still has not contacted you, call and request USA North to send a “Second No Response Follow-up” to the member(s) (name the particular member(s)) that has failed to respond to your notice. Request the member(s) to call and respond ASAP or call and provide clearance.

**3) Third No Response Follow-up:** Wait at least an hour or more, from your last call, to provide our member(s) an opportunity to call and respond to your second request. After this time has past and the member(s) still has not contacted you, call and request USA North, to send a “Third No Response Follow-up” to the member(s) (name the particular member(s)) that has failed to respond to your notice. Request the member(s) to call and respond ASAP or call and provide clearance. Note; the Center will attempt to make a call to the member(s) terminal involved and ask the member(s) to respond ASAP once the Third No Response Follow-up message has been transmitted.

**Warning:** There may be unidentified underground facilities at your job site. The excavator should review the job site for physical evidence of facilities not located, i.e. manholes, valve covers, water meters, sewer cleanouts, vaults, drains, fire hydrant, utility maintenance boxes, pole risers, or other facility indicators such as pavement patches etc.

---

### **Damage Notification:**

- An excavator discovering or causing damage to a sub-surface installation shall notify the operator of the installation and USA North.
  - USA North accepts damage / exposed notices from the excavator and transmits the notice to our members in the area of the damage. USA North will also provide the excavator with the emergency telephone number for the member whose facility was damaged.
- 

### **Emergency Notification:**

- If the damage results in the escape of any flammable, toxic, or corrosive gas or liquid or endangers life, health or property, the excavator responsible immediately notifies 911 and the facility owner/operator.
- The excavator takes reasonable measures to protect themselves and those in immediate danger, general public, property, and the environment until the facility owner / operator or emergency responders have arrived and completed their assessment.

## Suggested Guidelines for Prospective Excavation Site Delineation and Facility Operator Location Markout

### General Guidelines

This guide provides for temporary uniform surface marking of both planned excavations and of substructures in potential conflict of planned excavations. White markings are used for excavation delineation. Substructure markings are of a specific color. Appropriate color and common abbreviations are listed herein. Full facility operator and excavator responsibilities are detailed in Nevada Regulatory Statutes (NRS) 455.080 - 455.180 and in Nevada Administrative Code (NAC) 455.010 - 455.165.

Note: Temporary markings should be clearly seen, functional, and considerate to surface aesthetics and the local community. Also, check to see if any local ordinances apply. It is recommended that each operator and excavator use a consistent marking standard.

#### **Marking In Paved Areas**

Avoid excessive or oversized marking, especially if marking outside the excavation area. Conditions permitting, use spray chalk paint, water based paint, UV paint, or equivalent less permanent type marking. Limit length, height, and interval of marks to those recommended in this manual. Letters and numbers should not exceed 3" to 6" in height.

#### **Marking in Non-Paved Areas**

The use of appropriately colored flags, stakes, whiskers, or chalk lines should be used in non-paved areas. Select marker types that are most compatible to the purpose and marking surface. Adhere to paved area marking suggestions to the extent practical.

If any marking information is omitted due to site conditions, communicate omitted data by direct contact, signs, phone, fax, etc.

"Offset" markings should clearly indicate the direction, the distance, and the path of facility or excavation.

#### **Marking Removal**

We recommend that the permitting agency (Local, City, County, State, or Federal) require the permittee to remove all marking paint or other suitable markings at the conclusion of the excavation. Included are all excavator and utility operator (operator) markings that resulted from the project. This recommendation is based on the fact that the excavator has the knowledge of the specific area and limits of the excavation; they are required under NRS 455. 110, 1, (b), (2) to outline their excavation in white paint or other suitable markings; they requested to have the operators mark the

facilities which interface with the excavation; and they have the knowledge of when the excavation is completed. This will help eliminate graffiti on our streets and sidewalks caused by these markings and stop the erroneous use of out-dated operator's markings by other excavators.

### **Permitting Agencies**

We also recommend that permitting agencies (Local, City, County, State, or Federal) make excavators aware when multiple excavation permits are taken out for the same period of time and area. The agencies should advise each excavator that other excavators will be working within the same area and encourage them to communicate with one another so they do not destroy each other's excavation site markings or the markings of the operators responding to the multiple excavation sites.

### **Excavators**

Excavators should be specific when providing the description of the excavation area to USA North and when outlining their excavation area in white chalk paint or other suitable markings. This will help the operators to respond to the exact area of excavation and minimize their markings.

- Excavator's pre-marking (delineation) of the excavation site is a requirement of NRS 455.110, 1, (b), (2).
- Delineate the area to be excavated before calling USA North this is a requirement of NAC 455.115 1. (a). Delineated areas should be identified in white markings with the requester's company identifier (name, abbreviations or initials) within the pre-marked zones (see examples).
- Failure to pre-mark may result in civil penalties.
- NRS [455.110, 1, (b)] states "Cooperates with the operator in locating and identifying its subsurface installation by: (1) Meeting with its representative as requested; and (2) Making a reasonable effort that is consistent with the practice in the industry to mark with white paint, or another method that is agreed to by the operator..."
- Delineation must not be misleading, duplicative or misinterpreted as traffic or pedestrian control.

### **Operators**

To increase the accuracy of the locates when the facilities run through utility maintenance boxes, manholes, valve covers, splice boxes etc have your locators pull the lids to determine how many facilities enter and leave the boxes and which direction the facilities run. Operators marking outside the white outlined excavation area should include the USA North ticket number with their marks to identify which excavation site their marks were provided for.

## CGA Guidelines For Excavation Delineation

The following marking illustrations are examples of how excavators may choose to mark their area of proposed excavation. The use of white marking products (e.g. paint, flags, stakes, whiskers, or a combination of these) may be used to identify the excavation site.

### Single Point Excavations Markings

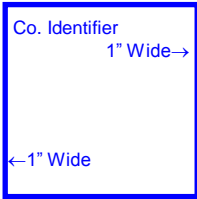

**Full Line**

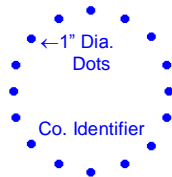

Dots to be less than 4' spacing

**Radius or Arc**

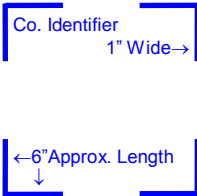

**Four Corner**

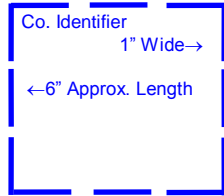

**Dash Line**

Delineate in white products the proposed area of excavation through the use of: a continuous line, dots marking the radius or arcs, dashes marking the four corners of the project or dashes outlining the excavation project. Limit the size of each dash to approximately 6" to 12" in length and 1" in width with interval spacing approximately 4' to 50' apart. The maximum separation of excavation marks is to be reduced to a length that can be reasonably seen by the operator's locators when the terrain or excavation site conditions warrant it. Dots of approximately 1" diameter are typically used to define arcs or radii and may be placed at closer intervals in lieu of dashes.

### Single Stake Marking Center Point of Excavation Site

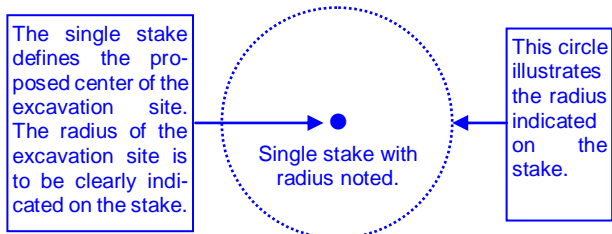

When an excavation site is contained within a 50' maximum radius, or less, it can be delineated with a single stake that is positioned at the proposed center of the excavation. If the excavator chooses this type of delineation they must convey that they have delineated the excavation site with a single stake at the center of the excavation and include the radius of the site in the notification to the One-Call Center. This single stake is to be white in color with the following information: excavator's company identifier (name, abbreviations, or initials) and the radius of the excavation site in black letters on the stake or with a notice attached to the stake.

**Trenching, Boring, or Other  
Continuous Types of Excavations**

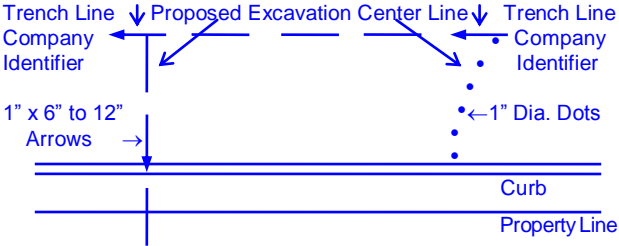

**Continuous Excavation Marking**

Mark in white paint the proposed centerline of planned excavation 6" to 12" x 1" arrows, approximately 4' to 50' apart to show direction of excavation. The maximum separation of excavation marks is to be reduced to a length that can be reasonably seen by the operator's locators when the terrain at an excavation site warrants it. Mark lateral excavations with occasional arrows showing excavation direction from centerline with marks at curb or property line if crossed. Dots may be used for curves and closer interval marking.

**Stakes, Flags or Whiskers Excavation Markers**

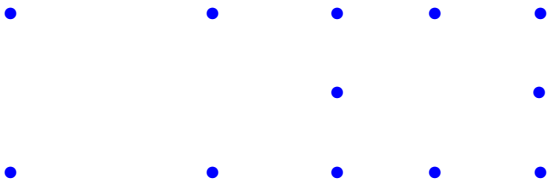

**Stakes, Flags or Whiskers  
Marking Four Corners**

**Stakes, Flags or Whiskers  
Marking Outline of Excavation**

Delineate the proposed area of excavation through the use of: stakes, flags or whiskers to mark radius or arcs, the four corners of the project or outlining the excavation project instead of using spray paint. Limit the interval spacing to

approximately 4' to 50'. The maximum separation of excavation marks is to be reduced to a length that can be reasonably seen by the operator's locators when the terrain at an excavation site warrants it. Stakes, flags or whiskers provided to illustrate arcs or radii may be placed at closer intervals in order to define the arc or radius. Stakes, flags or whiskers are white in color with the excavator's company identifier (name, abbreviations, or initials) provided on the stake, flag or whisker.

## CGA Guidelines For Operator's Facility Field Delineation

Operator markings of facilities include; the appropriate color for their facility type; their company identifier (name, initials, or abbreviation) when other companies are using the same color, the number and width of their facilities and a description of the facility (HP, FO, STL etc). Use paint, flags, stakes, whiskers or a combination to identify the operator's facility(s) at or near an excavation site.

- 1 Marks in the appropriate color are to be approximately 12" to 18" in length and 1" inch in width and separated by approximately 4' to 50' in distance as an example. When marking facilities the operator is to consider the type of facility being located, the terrain of the land, the type of excavation being done and the method to adequately mark its facilities for the excavator.

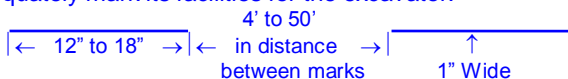

- 2 The following marking illustrations are examples of how an operator may choose to mark their subsurface installations

- a **Single Facility Marking:** Used to mark a single facility, marks are placed over the approximate center of the facility. This example indicates an operator's 12" facility. When a facility can be located or toned separately from other facilities of the same type it is marked as a single facility.

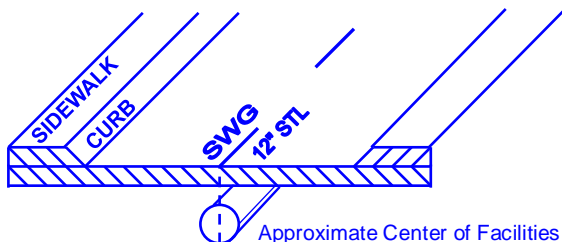

- b Multiple Facility Marking:** Used to mark multiple facilities of the same type (e.g. electric), where the separation does not allow for a separate tone for each facility but the number and width of the facilities is known. Marks are placed over the approximate center of the facilities and indicate the number and width of the facilities. This example indicates 4 plastic facilities that are 4" in diameter (4/4" PLA).

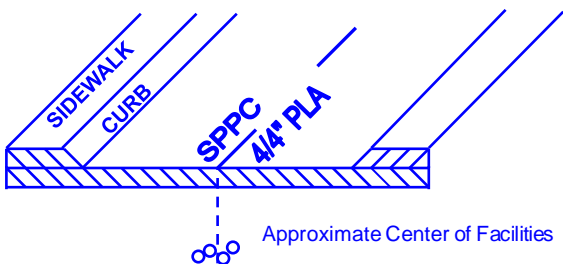

- c Conduit Marking:** Used for any locatable facility being carried inside conduits or ducts. The marks indicating the outer extremities denote the actual located edges of the facilities being represented. An example would be 4 plastic conduits that are 4" in diameter (4/4" PLA), and the marks are 16" apart indicating the actual left and right edges of the facilities.

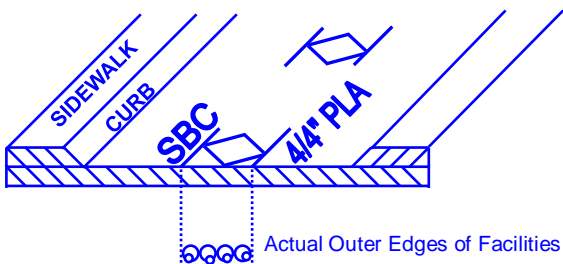

- d Corridor Marking:** Used to mark multiple facilities of the same type (e.g. electric), in the same trench where the total number of facilities is not readily known (operator has no record on file for the number facilities) and that are bundled or intertwined. Marks are placed over the approximate center of the facilities and indicate the width of the corridor. The width of the corridor is the distance between the actual located outside edges of the combined facilities. This example indicates a 12" corridor (12" CDR).

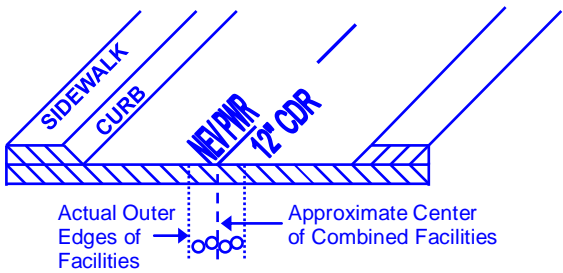

- 3** Changes in direction, and lateral connections are to be clearly indicated at the point where the change in direction or connection occurs with an arrow indicating the path of the facility. A radius is indicated with marks describing the arc. When providing offset markings, (paint or stakes), show the direction of the facility and distance to the facility from the markings.

**Radius Example!**

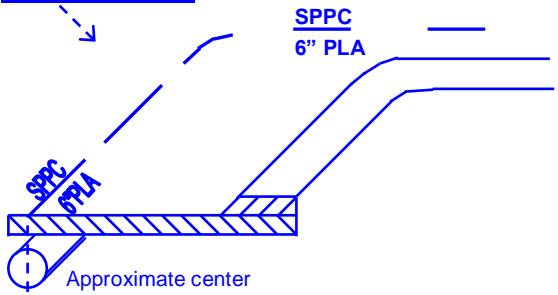

**Lateral Connection Example!**

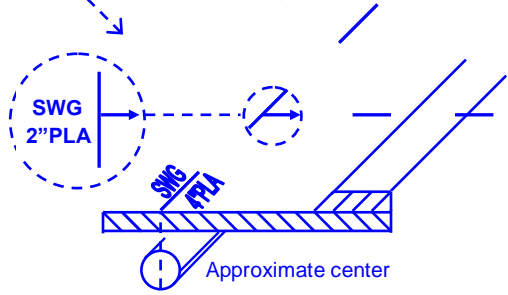

### Painted Offset (off) Example!

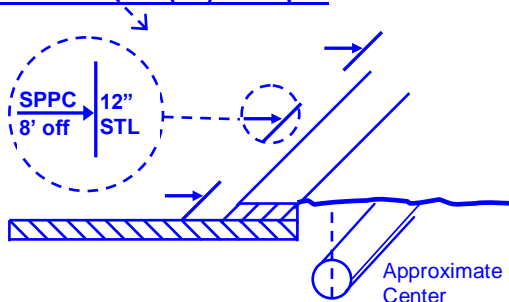

### Staked Offset (off) Example!

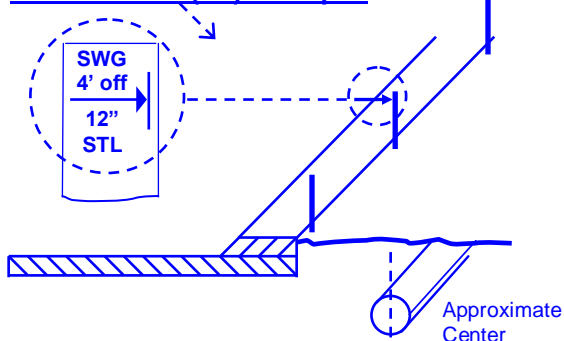

- 4** An operator's identifier (name, abbreviation or initials) is to be placed at the beginning and at the end of the proposed work. In addition to the previous, subsequent operators using the same color will mark their company identifier at all points where their facility crosses another operator's facility using the same color. The maximum separation of identifiers is to be reduced to a length that can be reasonably seen by the excavator when the terrain at the excavation site warrants it.

PAIUTE

AT&T

KRGT

- 5** Information as to the size and composition of the facility is to be marked at an appropriate frequency. Examples are: the number of ducts in a multi-duct structure, width of a pipeline, and whether it is steel, plastic, cable, etc.

SWG  
4" PLA

SBC  
9 PLA

SPPC  
12" STL

- 6** Facilities installed in a casing should be identified as such. Two examples are: 6" plastic in 12" steel = 6"PLA/12"STL and fiber optic in 4" steel = FO(4"STL).

SWG  
6"PLA/12"STL

SPRINT  
FO(4"STL)

- 7** Structures, such as vaults, inlets, lift stations that are physically larger than obvious surface indications, are to be marked so as to define the parameters of the structure.

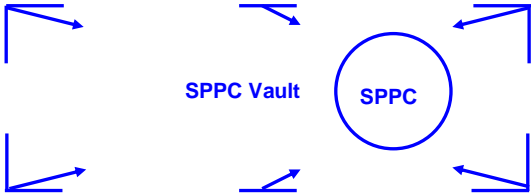

- 8** Termination points or dead ends should be indicated as such.

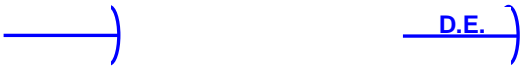

- 9** When there is "No Conflict" with the excavation complete one or more of the following:

- Operators of a single type of facility (e.g. AT&T) would mark the area "NO" followed by the appropriate company identifier in the matching APWA color code for that facility (e.g. "NO AT&T")
- Operators of multiple facilities would mark the area "NO" followed by the appropriate company identifier in the matching APWA color code for that facility with a slash and the abbreviation for the type of facility that there is "No Conflict" (e.g. "NO SWG/G/D"). The example illustrates that SWG has no gas distribution facilities at this excavation site. The abbreviation for; gas transmission facilities is "/G/T", electric distribution is "/E/D" and electric transmission is "/E/T" these should be used when appropriate.
- Place a clear plastic (translucent) flag that states "No Conflict" in lettering matching the APWA color code of the facility that is not in conflict. Include on the flag the operator's identifier, phone number, a place to write the locate ticket number and date. Operators of multiple facilities would indicate on the flag, which

facilities were in “No Conflict” with the excavation as in the previous example.

- If it can be determined through maps or records that the proposed excavation is obviously not in conflict with their facility (s) the locator or operator of the facility may notify the excavator of “No Conflict” by phone, fax, or email, or through the One-Call Center, where electronic positive response is used. Operators of multiple facilities would indicate a “No Conflict” for each facility as in the previous examples.
- Place “No Conflict” markings or flags in a location that can be observed by the excavator and or notify the excavator by phone, fax, or email that there is “No Conflict” with your facilities. When the excavation is delineated by the use of white markings, place “No Conflict” markings or flags in or as near as practicable to the delineated area.

\* Caution - Allow adequate space for all facility mark-outs.

“No Conflict” indicates; that the operator providing the “No Conflict” has no facilities within the scope of the delineation, or when there is no delineation, there are no facilities within the work area as described on the locate ticket.



### **Color Code Identifiers**

White	Proposed Excavation	Pink	Temporary Survey Markings
Red	Electric Power Lines, Cables, Conduit and Lighting Cables	Yellow	Gas, Oil, Steam, Petroleum or Gaseous Materials
Orange	Communication, Alarm or Signal Lines, Cables or Conduit	Blue	Potable Water
Purple	Reclaimed Water, Irrigation and Slurry Lines	Green	Sewers and Drain Lines

## Common Abbreviations:

### Facility Identifiers

CH	Chemical	SS	Storm Sewer
E	Electric	SL	Street Lighting
FO	Fiber Optic	STM	Steam
G	Gas	SP	Slurry System
LPG	Liquefied Petroleum Gas	TEL	Telephone
PP	Petroleum Products	TS	Traffic Signal
RR	Railroad Signal	TV	Television
S	Sewer	W	Water
SD	Storm Drain	W	Reclaimed Water "Purple"

### Underground Construction Descriptions

C	Conduit	HH	Hand Hole
CDR	Corridor	MH	Manhole
D	Distribution Facility	PB	Pull Box
DB	Direct Buried	R	Radius
DE	Dead End	STR	Structure (vaults, junction boxes, inlets, lift stations)
JT	Joint Trench	T	Transmission Facility
HP	High Pressure		

### Infrastructure Material

ABS	Acrylonitrile - Butadiene - Styrene	HDPE	High Density Polyethylene
ACP	Asbestos Cement Pipe	MTD	Multiple Tile Duct
CI	Cast Iron	PLA	Plastic (conduit or pipe)
CMC	Cement Mortar Coated	RCB	Reinforced Concrete Box
CML	Cement Mortar Lined	RCP	Reinforced Concrete Pipe
CPP	Corrugated Plastic Pipe	RF	Reinforced Fiberglass
CMP	Corrugated Metal Pipe	SCCP	Steel Cylinder Concrete Pipe
CU	Copper	STL	Steel
CWD	Creosote Wood Duct	VCP	Vertrified Clay Pipe

### **Guide for Abbreviation Use**

This is a guide for placing the above abbreviations in the field. The Company Identifier is to be placed at the top or at the left of the abbreviations. Place the abbreviations in the following order, Company Identifier/Facility Identifier / Underground Construction Descriptions / Infrastructure Material (e.g. SBC/TEL/FO/PLA). This example indicates that SBC has a Telecommunication Fiber Optic line in a single Plastic conduit. The use of the abbreviation /TEL is not necessary, because the orange marking would indicate that the facility was a communication line, but its use is optional. To leave out one or more of the abbreviation types you would continue to follow the order of the abbreviations above leaving out the slash and abbreviation that does not apply (e.g. /TEL), the result would be the following (e.g. SBC/FO/PLA).

---

## **Nevada Revised Statutes (NRS)** **455.080 - 455.180**

**NRS 455.080 Definitions.** As used in NRS 455.080 to 455.180, inclusive, unless the context otherwise requires, the words and terms defined in and NRS 455.082 to 455.105, inclusive, have the meanings ascribed to them in those sections. (Added to NRS by 1991, 1141; A 2005, 905)

**NRS 455.082 “Approximate location of a subsurface installation” defined. [Effective through June 30, 2008.]** “Approximate location of a subsurface installation” means a strip of land not more than 30 inches on either side of the exterior surface of a subsurface installation. The term does not include the depth of the subsurface installation. (Added to NRS by 1991, 1142)

**NRS 455.082 “Approximate location of a subsurface installation” defined. [Effective July 1, 2008.]** “Approximate location of a subsurface installation” means a strip of land not more than 24 inches on either side of the exterior surface of a subsurface installation. The term does not include the depth of the subsurface installation. (Added to NRS by 1991, 1142; A 2007, 675, effective July 1, 2008)

**NRS 455.084 “Association for operators” defined.** “Association for operators” means an organization that receives notifications pursuant to subsection 1 of NRS 455.110 and transmits such notifications to its members. (Added to NRS by 1991, 1142)

**NRS 455.086 “Damage”** defined. “Damage” means:

1. The substantial weakening of the structural or lateral support of a subsurface installation;
2. The penetration or destruction of any protective coating, housing or other protective device of a subsurface installation; or
3. The partial or complete severance of a subsurface installation. (Added to NRS by 1991, 1142)

**NRS 455.088 “Demolition”** defined. “Demolition” means the wrecking, razing, rendering, movement or removal of a structure or mass of material by means of tools, equipment or the placement and discharge of explosives. (Added to NRS by 1991, 1142)

**NRS 455.090 “Emergency”** defined. “Emergency” means a sudden, unexpected occurrence that involves clear and imminent danger and requires immediate action to prevent or mitigate loss of life or damage to health, property or essential public services. (Added by NRS by 1991, 1142)

**NRS 455.092 “Excavation”** defined. “Excavation” means the movement or removal of earth, rock or other material in or on the ground by use of mechanical equipment or by the placement and discharge of explosives. The term includes augering, backfilling, digging, ditching, drilling, grading, plowing-in, ripping, scraping, trenching and tunneling. (Added by NRS by 1991, 1142)

**NRS 455.094 “Mechanical equipment”** defined. “Mechanical equipment” means equipment operated by mechanical power, including a trencher, bulldozer, power shovel, auger, backhoe, scraper, drill, cable or pipe plow or any other equipment used for plowing-in cable or pipe. (Added to NRS by 1991, 1942)

**NRS 455.096 “Operator”** defined. “Operator” means any person who owns, operates or maintains a subsurface installation. The term does not include the Department of Transportation. (Added to NRS by 1991, 1942)

**NRS 455.098 “Person”** defined. “Person” includes a government, governmental agency or political subdivision of a government. (Added to NRS by 1991, 1942)

**NRS 455.101 “Subsurface installation”** defined. “Subsurface installation” means a pipeline, conduit, cable, duct, wire, sewer line, storm drain, other drain line or other structure that is located underground. (Added to NRS by 1991, 1142)

**NRS 455.103 “Unexpected occurrence”** defined. “Unexpected occurrence” includes, but is not limited to, fire, flood, earthquake or other cause of the movement of the soil, or a riot, an accident or an act of sabotage that causes damage

to a subsurface installation which requires immediate repair. (Added to NRS by 1991, 1142)

**NRS 455.105 “Working day”** defined. “Working day” means every day from 7 a.m. to 5 p.m., except Saturday, Sunday and any federal or state holiday. (Added to NRS by 1991, 1142)

**NRS 455.107 Exemption from compliance with statutory provisions.**

1. Except as otherwise provided in subsection 2, possession of a permit to conduct an excavation or demolition does not exempt a person from complying with the provisions of NRS 455.080 to 455.180, inclusive.

2. A person is exempt from complying with the provisions of NRS 455.080 to 455.180, inclusive, if he obtains the written consent of all operators involved in the proposed excavation or demolition before he receives a permit to conduct the excavation or demolition. (Added to NRS by 1991, 1142; 2005, 905)

**NRS 455.110 Notification of association for operators required; marking proposed area of excavation or demolition; exception.**

1. Except as otherwise provided in subsection 2, a person shall not begin an excavation or demolition if the excavation or demolition is to be conducted in an area that is known or reasonably should be known to contain a subsurface installation, except a subsurface installation owned or operated by the person conducting the excavation or demolition, unless he:

(a) Notifies the appropriate association for operators pursuant to NRS 455.120, at least 2 working days but not more than **28** calendar days before excavation or demolition is scheduled to commence. The notification may be written or provided by telephone and must state the name, address and telephone number of the person who is responsible for the excavation or demolition, the starting date of the excavation or demolition, anticipated duration and type of excavation or demolition to be conducted, the specific area of the excavation or demolition and whether explosives are to be used.

(b) Cooperates with the operator in locating and identifying its subsurface installation by:

(1) Meeting with its representative as requested; and  
(2) Making a reasonable effort that is consistent with the practice in the industry to mark with white paint, flags, stakes, whiskers or another method that is agreed to by the operator and the person who is responsible for the excavation or demolition, the proposed area of the excavation or demolition.

2. A person responsible for emergency excavation or demolition is not required to comply with the provisions of

subsection 1 if there is a substantial likelihood that loss of life, health or property will result before the provisions of subsection 1 can be fully complied with. The person shall notify the operator of the action he has taken as soon as practicable. (Added to NRS by 1987, 1178; A 1991, 1145; 2005, 906; **2007, 675**)

**NRS 455.115 Record of notification of excavation or demolition; provision of names of operators to whom notice is transmitted by association for operators.**

1. An association for operators who receives notification pursuant to NRS 455.110 by telephone and an operator who receives notification of a proposed excavation or demolition by telephone shall keep a written record of the notification for 6 years. The record must include, but is not limited to, the following information:

- (a) The name of the person initiating the telephone call;
- (b) The name, address and telephone number of the person who is responsible for the excavation or demolition;
- (c) The starting date and anticipated duration of the excavation or demolition;
- (d) The type of excavation or demolition to be conducted;
- (e) The specific area of the excavation or demolition; and
- (f) Whether explosives are to be used.

2. If a person makes a notification to an association for operators pursuant to NRS 455.110, the association for operators shall provide to the person the names of the operators to whom the notice is transmitted by the association. (Added to NRS by 1991, 1144)

**NRS 455.120 Operator required to join association for operators to receive notifications; statement to be filed with county clerk identifying association; record of notification received by telephone.** An operator shall:

1. Join an association for operators to receive the notification required pursuant to paragraph (a) of subsection 1 of NRS 455.110 for its members.

2. File a statement with the clerk of the county in which the business of the operator is located:

- (a) Containing the name, telephone number and address of the association; and
- (b) Describing the geographical area served by the association for operators.

3. Make a written record of each notification of a proposed excavation or demolition that he receives by telephone. (Added to NRS by 1987, 1178; A 1991, 1146)

**NRS 455.130 Duties of operator upon receipt of notification.**

1. Except in an emergency or as otherwise provided in subsection 2, if an operator receives notice through an association for operators pursuant to paragraph (a) of subsection 1 of NRS 455.110, the operator shall:

(a) Locate and identify the subsurface installations and, if known, the number of subsurface installations that are affected by the proposed excavation or demolition to the extent and to the degree of accuracy that the information is available in the records of the operator or can be determined by using techniques of location that are commonly used in the industry, except excavating, within 2 working days or within a time mutually agreed upon by the operator and the person who is responsible for the excavation or demolition;

(b) Remove or protect a subsurface installation as soon as practicable if the operator decides it should be removed or protected; and

(c) Advise the person who contacted the association for operators of the location of the subsurface installations of the operator that are affected by the proposed excavation or demolition.

2. The operator shall notify the person who contacted the association for operators if the operator has no subsurface installations that are affected by the proposed excavation or demolition. (Added to NRS by 1987, 1178; A 1991, 1146)

### **NRS 455.131 Use of permanent device to identify location of certain subsurface installations required.**

1. An operator shall, for each subsurface installation that is installed on or after October 1, 2005, which cannot be detected from or above the surface of the ground by means of either the material used in constructing the subsurface installation or a conductor within the subsurface installation, install a permanent device which designates or provides a means of detecting a subsurface installation through the use of a noninvasive method from or above the surface of the ground. Such a device includes, without limitation, a tracer wire or a marker.

2. As used in this section:

(a) "Above ground marker" is a marker which is installed flush with the surface of the ground or which protrudes above the surface of the ground above a subsurface installation and includes information concerning the subsurface installation.

(b) "Electronic marker" is a marker which is buried at various depths below or near the surface of the ground above a subsurface installation and which contains a passive antenna that:

- (1) Can be identified with detection equipment; and
- (2) Does not require an internal power source.

(c) "Marker" is a device that physically designates the location of a subsurface installation at intermittent locations

along or above the subsurface installation and includes, without limitation, an above ground marker or electronic marker.

(d) "Tracer wire" is a locating wire which is installed in conjunction with a subsurface installation and is connected to a transmitter that carries a signal which is read by a receiver above the surface of the ground for the detection of the location of the subsurface installation. (Added to NRS by 2005, 904)

### **NRS 455.133 Criteria and colors for marking location of subsurface installation: Regulations of Public Utilities Commission of Nevada.**

1. An operator who marks the approximate location of a subsurface installation shall make a reasonable effort to make the markings in a manner that is consistent with the practice in the industry. The operator shall use the identifying criteria and colors set forth in the regulations of the Public Utilities Commission of Nevada for the markings.

2. In adopting regulations setting forth the criteria and colors to be used pursuant to this section, the Public Utilities Commission of Nevada shall use nationally accepted standards for the identifying criteria and colors for marking subsurface installations. (Added to NRS by 1991, 1143; A 2005, 906)

### **NRS 455.137 Determination of location of subsurface installation required before mechanical equipment may be used.**

1. Except as otherwise provided in subsection 2, the person responsible for an excavation or demolition shall, before using any mechanical equipment, determine the exact location of a subsurface installation that is affected by the excavation or demolition by excavating with hand tools or by any other method agreed upon by the person responsible for the excavation or demolition and the operator within the approximate location of the subsurface installation as designated by markings made in accordance with NRS 455.133.

2. A person may use mechanical equipment for the removal of pavement if there are no subsurface installations contained in the pavement.

3. If the exact location of a subsurface installation cannot be determined by using hand tools, the person responsible for an excavation or demolition shall request the operator to provide additional information to locate the installation. The operator shall, within 1 working day, provide any information that is available to him to enable the person responsible for the excavation or demolition to determine the exact location of the installation. (Added to NRS by 1991, 1143)

### **NRS 455.140 Duties of person responsible for contact with, exposure of or damage to subsurface installation.**

1. Each person responsible for any excavation or demolition that results in contact with, exposure of or damage to a subsurface installation shall:

(a) Notify the operator of the location and nature of the damage; and

(b) Allow the operator reasonable time, consistent with the practice in the industry, to arrange for and to make any necessary repairs to the subsurface installation before completing the excavation or demolition in the immediate area of the subsurface installation.

2. Each person responsible for any excavation or demolition that results in any damage to a subsurface installation which permits the escape of water, of any flammable, toxic or corrosive gas or liquid, or of electricity, shall:

(a) Notify the operator; and

(b) Minimize the hazard until the arrival of the personnel of the operator. (Added to NRS by 1987, 1178; A 1991, 1146)

**NRS 455.150 Release from liability for cost of repairs to subsurface installation.** Any person who substantially complies with the provisions of NRS 455.080 to 455.180, inclusive, is not liable for the cost of repairing any damage to a subsurface installation which results from his excavation or demolition. (Added to NRS by 1987, 1179; A 1991, 1147)

#### **NRS 455.160 Injunctive relief.**

1. The Regulatory Operations Staff of the Public Utilities Commission of Nevada, the Attorney General, an operator, a person conducting an excavation or demolition or the district attorney of a county or the city attorney of a city in which there is an excavation or demolition or a proposed excavation or demolition which he believes may cause death, serious physical harm or serious property damage may file a complaint in the district court for the county seeking to enjoin the activity or practice of an operator or a person who is responsible for the excavation or demolition.

2. Upon the filing of a complaint pursuant to subsection 1, the court may issue a temporary restraining order before holding an evidentiary hearing. (Added to NRS by 1991, 1143; A 1997, 2000; 2007, 675)

#### **NRS 455.170 Civil penalty: Action for enforcement; amount; reimbursement for cost of prosecution; judicial review.**

1. An action for the enforcement of a civil penalty pursuant to this section may be brought before the Public Utilities Commission of Nevada by the Attorney General, a district attorney, a city attorney, the Regulatory Operations Staff of the Public Utilities Commission of Nevada, the governmental agency that issued the permit to conduct an

excavation or demolition, an operator or a person conducting an excavation or demolition.

2. Any person who willfully or repeatedly violates a provision of NRS 455.080 to 455.180, inclusive, is liable for a civil penalty:

(a) Not to exceed \$1,000 per day for each violation; and

(b) Not to exceed \$100,000 for any related series of violations within a calendar year.

3. Any person who negligently violates any such provision is liable for a civil penalty:

(a) Not to exceed \$200 per day for each violation; and

(b) Not to exceed \$1,000 for any related series of violations within a calendar year.

4. The amount of any civil penalty imposed pursuant to this section and the propriety of any settlement or compromise concerning a penalty must be determined by the Public Utilities Commission of Nevada upon receipt of a complaint by the Attorney General, the Regulatory Operations Staff of the Public Utilities Commission of Nevada, a district attorney, a city attorney, the agency that issued the permit to excavate or the operator or the person responsible for the excavation or demolition.

5. In determining the amount of the penalty or the amount agreed upon in a settlement or compromise, the Public Utilities Commission of Nevada shall consider:

(a) The gravity of the violation;

(b) The good faith of the person charged with the violation in attempting to comply with the provisions of NRS 455.080 to 455.180, inclusive, before and after notification of a violation; and

(c) Any history of previous violations of those provisions by the person charged with the violation.

6. A civil penalty recovered pursuant to this section must first be paid to reimburse the person who initiated the action for any cost incurred in prosecuting the matter.

7. Any person aggrieved by a determination of the Public Utilities Commission of Nevada pursuant to this section may seek judicial review of the determination in the manner provided by NRS 703.373. (Added to NRS by 1991, 1144; A 1997, 2000; 2005, 907; 2007, 675)

**NRS 455.180 Civil remedies preserved; additional civil remedy not created.** The provisions of NRS 455.080 to 455.170, inclusive, do not affect any civil remedies provided by law for personal injury or property damage and do not create a new civil remedy for any personal injury or property damage. (Added to NRS by 1991, 1145)

---

## **Nevada Administrative Code (NAC)**

### **455.010 - 455.165**

Please NOTE the instructions in the next two paragraphs will explain how you can identify changes in the NAC 455 printed in this manual.

SINGLE UNDERLINING indicates portions of text added to the NAC 455 from LCB File No. R153-07 Proposed Regulation of the Public Utility Commission of Nevada Docket 07-06018.

DOUBLE UNDERLINING indicates portions of text added to the NAC 455 from the Public Utility Commission of Nevada Docket 08-01009

Section 1. Chapter 455 of NAC is hereby amended by adding thereto a new section to read as follows:

*All occurrences of contact with, exposure of or damage to a subsurface installation resulting from any excavation or demolition shall be reported by both the excavator and operator to the Regulatory Operations Staff within 5 business days of the occurrence on a form provided on the Commission's website. This provision is applicable to all occurrences between January 1, 2008 and December 31, 2008.*

Section 1. Chapter 455 of NAC is hereby amended by adding thereto the provisions set forth as sections 2 to 4, inclusive, of this regulation.

Sec. 2. "Sewer system operator" is an operator as defined by NRS 455.096.

Sec. 3. "Sewer lateral" is a subsurface installation as defined by NRS 455.101.

Sec. 4. Upon receipt of a notice through an association for operators pursuant to NRS 455.110(1)(a) of an excavation or demolition, a sewer system operator shall locate and identify all sewer laterals connected to a main in the operator's sewer system pursuant to NRS 455.130. Section 4 of this regulation does not apply to the portion of any sewer lateral located within the property boundary of a customer of a sewer system operator.

**NAC 455.010 Definitions.** (NRS 703.025, 704.260, 704.280) As used in this chapter, unless the context otherwise requires, the words and terms defined in NAC 455.015 to 455.095, inclusive, have the meanings ascribed to them in those sections. (Added to NAC by Pub. Utilities Comm'n by R156-03, eff. 8-25-2004; A by R048-06, 9-18-06)

**NAC 455.015 "Affected area of the proposed excavation or demolition" defined.** (NRS 703.025, 704.260,

704.280) “Affected area of the proposed excavation or demolition” means the area that is:

1. Within the perimeter of the proposed area of the excavation or demolition; and
2. Within 24 inches horizontally of the perimeter of the proposed area of the excavation or demolition.

(Added to NAC by Pub. Utilities Comm’n by R156-03, eff. 8-25-2004)

**NAC 455.020 “Approximate location of a subsurface installation” defined.** (NRS 703.025, 704.260, 704.280) “Approximate location of a subsurface installation” has the meaning ascribed to it in NRS 455.082. (Added to NAC by Pub. Utilities Comm’n by R156-03, eff. 8-25-2004)

**NAC 455.025 “Association for operators” defined.** (NRS 703.025, 704.260, 704.280) “Association for operators” has the meaning ascribed to it in NRS 455.084. (Added to NAC by Pub. Utilities Comm’n by R156-03, eff. 8-25-2004)

**NAC 455.030 “Commission” defined.** (NRS 703.025, 704.260, 704.280) “Commission” means the Public Utilities Commission of Nevada. (Added to NAC by Pub. Utilities Comm’n by R156-03, eff. 8-25-2004)

**NAC 455.035 “Damage” defined.** (NRS 703.025, 704.260, 704.280) “Damage” has the meaning ascribed to it in NRS 455.086. (Added to NAC by Pub. Utilities Comm’n by R156-03, eff. 8-25-2004)

**NAC 455.040 “Demolition” defined.** (NRS 703.025, 704.260, 704.280) “Demolition” has the meaning ascribed to it in NRS 455.088. (Added to NAC by Pub. Utilities Comm’n by R156-03, eff. 8-25-2004)

**NAC 455.045 “Emergency” defined.** (NRS 703.025, 704.260, 704.280) “Emergency” has the meaning ascribed to it in NRS 455.090. (Added to NAC by Pub. Utilities Comm’n by R156-03, eff. 8-25-2004)

**NAC 455.050 “Excavation” defined.** (NRS 703.025, 704.260, 704.280) “Excavation” has the meaning ascribed to it in NRS 455.092. (Added to NAC by Pub. Utilities Comm’n by R156-03, eff. 8-25-2004)

**NAC 455.055 “Excavator” defined.** (NRS 703.025, 704.260, 704.280) “Excavator” means any person who directly or through an employee performs an excavation or demolition. (Added to NAC by Pub. Utilities Comm’n by R156-03, eff. 8-25-2004)

**NAC 455.060 “Identify” defined.** (NRS 703.025, 704.260, 704.280) “Identify” means to describe:

1. The type of a subsurface installation; and
2. If the subsurface installation has a diameter or width of more than 2 inches, the diameter or width and composition of the subsurface installation, if reasonably known.

The term does not include describing the depth of a subsurface installation. (Added to NAC by Pub. Utilities Comm’n by R156-03, eff. 8-25-2004)

**NAC 455.065 “Locate” defined.** (NRS 703.025, 704.260, 704.280) “Locate” means to determine the location of a subsurface installation. The term does not include determining the depth of the subsurface installation. (Added to NAC by Pub. Utilities Comm’n by R156-03, eff. 8-25-2004)

**NAC 455.067 “Marking practices in the industry” defined.** (NRS 703.025, 704.260, 704.280) “Marking practices in the industry” means the marking standards adopted by reference in NAC 455.105. (Added to NAC by Pub. Utilities Comm’n by R048-06, eff. 9-18-2006)

**NAC 455.070 “Notification” defined.** (NRS 703.025, 704.260, 704.280) “Notification” means a notice of an excavation or demolition submitted by an excavator to an association for operators. (Added to NAC by Pub. Utilities Comm’n by R156-03, eff. 8-25-2004)

**NAC 455.075 “Operator” defined.** (NRS 703.025, 704.260, 704.280) “Operator” has the meaning ascribed to it in NRS 455.096. (Added to NAC by Pub. Utilities Comm’n by R156-03, eff. 8-25-2004)

**NAC 455.080 “Person” defined.** (NRS 703.025, 704.260, 704.280) “Person” has the meaning ascribed to it in NRS 455.098. (Added to NAC by Pub. Utilities Comm’n by R156-03, eff. 8-25-2004)

**NAC 455.085 “Proposed area of the excavation or demolition” defined.** (NRS 703.025, 704.260, 704.280) “Proposed area of the excavation or demolition” means the area identified by the excavator pursuant to the provisions of NAC 455.115 and subparagraph (2) of paragraph (b) of subsection 1 of NRS 455.110. (Added to NAC by Pub. Utilities Comm’n by R156-03, eff. 8-25-2004)

**NAC 455.090 “Subsurface installation” defined.** (NRS 703.025, 704.260, 704.280) “Subsurface installation” has the meaning ascribed to it in NRS 455.101. (Added to NAC by Pub. Utilities Comm’n by R156-03, eff. 8-25-2004)

**NAC 455.095 “Working day” defined.** (NRS 703.025, 704.260, 704.280) “Working day” has the meaning ascribed

to it in NRS 455.105. (Added to NAC by Pub. Utilities Comm'n by R156-03, eff. 8-25-2004)

**NAC 455.100 “Association for operators” deemed to be Underground Service Alert North.** (NRS 455.084, 703.025, 704.260, 704.280) For the purposes of this chapter and NRS 455.080 to 455.180, inclusive, the “association for operators,” as described in NRS 455.084, shall be deemed to be Underground Service Alert North, or its successor organization. (Added to NAC by Pub. Utilities Comm'n by R156-03, eff. 8-25-2004)

**NAC 455.105 Marking standards: Adoption by reference; availability.** (NRS 455.133, 703.025, 704.260, 704.280)

1. The Commission hereby adopts by reference the marking standards described in the:

- (a) “Uniform Color Code”;
- (b) “Guidelines for Excavation Delineation”; and
- (c) “Guidelines for Operator’s Facility Field Delineation,” as set forth in Appendix B of Best Practices Version 3.0, published by the Common Ground Alliance.

2. A copy of this publication can be obtained from the Common Ground Alliance, free of charge, at the Internet address <http://www.commongroundalliance.com/>. (Added to NAC by Pub. Utilities Comm'n by R048-06, eff. 9-18-2006)

**NAC 455.107 Marking standards: Controlling provisions.** (NRS 455.133, 703.025, 704.260, 704.280) If there is a conflict between the marking practices in the industry and the other provisions of this chapter, the other provisions of this chapter control. (Added to NAC by Pub. Utilities Comm'n by R048-06, eff. 9-18-2006)

**NAC 455.110 Notification of association for operators: Required information.** (NRS 455.110, 703.025, 704.260, 704.280) In addition to the requirements set forth in paragraph (a) of subsection 1 of NRS 455.110, an excavator submitting a notification shall provide to the association for operators:

1. If applicable, the number of the facsimile machine at which the excavator can receive documents;

2. If applicable, the electronic mail address at which the excavator can be contacted;

3. If the affected area of the proposed excavation or demolition was the subject of a previous notification submitted by the excavator, information relating to the previous notification; and

4. Any additional information relating to the excavation or demolition that is requested by the association for opera-

tors. (Added to NAC by Pub. Utilities Comm'n by R156-03, eff. 8-25-2004)

**NAC 455.115 Marking of proposed area of excavation or demolition; exemption from requirement for notification.** (NRS 455.110, 703.025, 704.260, 704.280)

1. An excavator who marks the proposed area of an excavation or demolition pursuant to the provisions of subparagraph (2) of paragraph (b) of subsection 1 of NRS 455.110 shall mark:

(a) The area before submitting a notification; and

(b) Only the area that can reasonably be excavated or demolished within 28 calendar days after the date the excavator submitted the notification of the excavation or demolition to the association for operators pursuant to the provisions of NRS 455.110.

**NAC 455.120 Association for operators: Dissemination of information received in notification.** (NRS 455.115, 703.025, 704.260, 704.280) In addition to the requirements set forth in NRS 455.115, an association for operators that receives a notification pursuant to the provisions of NRS 455.110 shall transmit the information contained in the notification to all members of the association for operators who have reported to the association for operators that they own, operate, maintain or control a subsurface installation in the affected area of the proposed excavation or demolition. (Added to NAC by Pub. Utilities Comm'n by R156-03, eff. 8-25-2004)

**NAC 455.125 Duties of operator upon receipt of notification from association for operators.** (NRS 455.130, 455.133, 703.025, 704.260, 704.280)

1. An operator locating and identifying subsurface installations pursuant to the provisions of paragraph (a) of subsection 1 of NRS 455.130 shall locate and identify all subsurface installations of the operator that are in use or held for prospective use and are located within the affected area of the proposed excavation or demolition and shall:

(a) Mark the approximate location of the subsurface installations located and identified as required by NRS 455.133 and NAC 455.130 or in another manner agreed to in writing between the excavator and the operator; or

(b) For any subsurface installations of the operator that the operator was unable to identify or locate according to the records of the operator:

(1) Inform the excavator of the approximate location of the subsurface installation; and

(2) Provide to the excavator the best description available of the subsurface installation from those records.

2. If an operator determines that it has no subsurface installations within the affected area of the proposed excavation or demolition, the operator shall notify the excavator pursuant to the provisions of subsection 2 of NRS 455.130 by:

(a) Notifying the excavator directly; or

(b) Making a mark which indicates that the operator has no subsurface installations within the affected area of the proposed excavation or demolition in a manner that:

(1) Is consistent with the practice in the industry; or

(2) Includes the name, initials or logo of the operator.

(Added to NAC by Pub. Utilities Comm'n by R156-03, eff. 8-25-2004)

**NAC 455.130 Marking location of subsurface installation.** (NRS 455.130, 455.133, 703.025, 704.260, 704.280)

1. Except as otherwise provided in subsection 2 or when otherwise agreed to by an operator and an excavator, an operator marking the approximate location of a subsurface installation that has been located and identified pursuant to the provisions of NAC 455.125 shall mark the approximate location of the subsurface installation in a manner consistent with the marking practices in the industry.

2. The requirement of marking the approximate location of a subsurface installation does not apply to an individual irrigation system for landscaping or to a playing field. (Added to NAC by Pub. Utilities Comm'n by R156-03, eff. 8-25-2004; A by R048-06, 9-18-2006)

**NAC 455.135 Marks: Duties of excavator.** (NRS 455.137, 703.025, 704.260, 704.280)

1. Until an excavation or demolition is completed, an excavator shall maintain the marks:

(a) Of the proposed area of an excavation or demolition made by the excavator pursuant to the provisions of subparagraph (2) of paragraph (b) of subsection 1 of NRS 455.110; and

(b) Of the approximate location of subsurface installations made by an operator pursuant to paragraph (b) of subsection 1 of NAC 455.125.

2. Upon a request from the excavator for additional markings when the excavator determines that it will be unable to maintain the operator's markings due to the type of excavation or demolition being conducted, the excavator shall communicate that request along with the reasons for the request to the operator. Upon joint determination by the excavator and operator of the type of additional markings,

the operator shall provide offsets, whiskers, flags or any other means that are consistent with the industry practice and as agreed with the excavator.

3. If, before the commencement of an excavation or demolition or during an excavation or demolition the marks are removed, obliterated, covered or otherwise become disturbed or the excavator has concerns regarding the accuracy and meaning of the marks prior to confirming the exact location of the marked subsurface installations pursuant to NRS 455.137, the excavator shall:

(a) If the excavator has begun the excavation or demolition, cease the excavation or demolition in the affected area (s); and

(b) Submit a notification to the association for operators that requests the operators with subsurface installations in the affected area(s) of the proposed excavation or demolition to mark, confirm prior marks or make replacement marks for the subsurface installations in the affected area(s) of the proposed excavation or demolition.

4. Excavators may submit a notification to the association for operators that requests replacement marks be made by the operator if the existing marks are fading, partially removed or have otherwise been disturbed in such a manner that without replacement marks, the excavator will soon be required to cease the excavation or demolition.

**NAC 455.140 Marks: Prohibited acts; removal upon completion of excavation or demolition.** (NRS 703.025, 704.260, 704.280)

1. Except as otherwise provided in subsection 2, an excavator, an operator or any other person shall not create, remove, change or modify a mark made by an excavator or an operator in an affected area of a proposed excavation or demolition for the purpose of violating a provision of this chapter or NRS 455.080 to 455.180, inclusive.

2. Except as otherwise provided in NAC 455.160, an excavator or operator may remove a mark made by the excavator or an operator if the excavation or demolition has been completed. (Added to NAC by Pub. Utilities Comm'n by R156-03, eff. 8-25-2004)

**NAC 455.145 Restrictions upon and duties of excavator before commencement of excavation or demolition.** (NRS 455.137, 703.025, 704.260, 704.280)

1. Except when commencing an emergency excavation as provided in the provisions of subsection 2 of NRS 455.110, an excavator:

(a) Shall not commence an excavation or demolition:

(1) Until each operator of a subsurface installation within the affected area of the proposed excavation or demolition has marked the location or has provided the approximate location of the subsurface installations of the operator pursuant to the provisions of NAC 455.125; and

(2) Before:

(I) The date and time the excavator identified as the date and time of commencement of the excavation or demolition; and

(II) Two working days after the date and time the excavator provided notification to the association for operators.

(b) To ensure that all subsurface installations in the affected area have been properly located and identified, shall not commence an excavation or demolition until the excavator has reviewed:

(1) All marks made by operators pursuant to the provisions of NAC 455.125;

(2) All marks made by the excavator pursuant to the provisions of NAC 455.115;

(3) All other information regarding subsurface installations provided to the excavator by an operator with subsurface installations in the affected area of the proposed excavation or demolition; and

(4) All other evidence that is visible of the approximate location of subsurface installations in the affected area of the proposed excavation or demolition.

2. In addition to the requirements provided in subsection 1, if an excavator is commencing an excavation or demolition pursuant to subparagraph (2) of paragraph (a) of subsection 1 and each operator of a subsurface installation within the affected area of the proposed excavation or demolition has not marked or otherwise identified the location of the subsurface installations of the operator pursuant to the provisions of NAC 455.125, the excavator shall, before commencing the excavation or demolition, provide notification to the association for operators and request that each operator who has a subsurface installation that has not been marked return and mark the subsurface installation in the affected area of the proposed excavation or demolition. (Added to NAC by Pub. Utilities Comm'n by R156-03, eff. 8-25-2004)

**NAC 455.150 Duties of excavator: Procedures for conducting excavation or demolition.** (NRS 455.137, 703.025, 704.260, 704.280)

1. An excavator conducting an excavation or demolition shall proceed in a careful and prudent manner.

2. In accordance with the provisions of NRS 455.137, the excavator shall, when conducting an excavation or demolition within the approximate location of a subsurface installation, determine the exact location of the subsurface installation by excavating with hand tools or by any other method agreed upon by the excavator and the operator having responsibility for the subsurface installation before using any mechanical equipment.

3. If, during the course of an excavation or demolition, an excavator is unable to determine the exact location of a subsurface installation within 24 horizontal inches of a mark placed by an operator, the excavator shall notify immediately the association for operators and the operator who placed the mark.

4. If, during the course of an excavation or demolition, an excavator discovers any subsurface installation, the excavator shall provide the lateral and subjacent support of the subsurface installation that is needed to ensure the protection and stability of the subsurface installation. (Added to NAC by Pub. Utilities Comm'n by R156-03, eff. 8-25-2004)

**NAC 455.155 Duties of excavator: Discovery of unmarked subsurface installation during course of excavation or demolition. (NRS 455.137, 703.025, 704.260, 704.280)**

1. In addition to the requirements set forth in subsection 4 of NAC 455.150 if, during the course of an excavation or demolition, an excavator discovers a subsurface installation the location of which was not marked or otherwise identified by an operator pursuant to the provisions of NAC 455.125, the excavator shall:

(a) Before continuing with the excavation or demolition, inform the owner of the subsurface installation, if known, of the discovery of the subsurface installation; and

(b) As soon as practical, provide notification to the association for operators of the discovery of the subsurface installation.

2. The association for operators shall transmit the information contained in the notification made by the excavator to the operator of the subsurface installation discovered by the excavator.

3. Upon receipt of the notification by the excavator or the association for operators of a subsurface installation the location of which was not marked, the operator shall locate and identify and mark the subsurface installation pursuant

to the provisions of NAC 455.125. (Added to NAC by Pub. Utilities Comm'n by R156-03, eff. 8-25-2004)

**NAC 455.160 Duties of excavator: Causing or observing damage to subsurface installation during excavation or demolition.** (NRS 455.140, 703.025, 704.260, 704.280)

1. If an excavator causes or observes any damage, including, without limitation, a scratch, kink, stretch mark or any other unusual condition, to a subsurface installation during an excavation or demolition, the excavator shall:

(a) Cease work on the excavation or demolition in the area around the damaged subsurface installation;

(b) Inform the operator of the subsurface installation of the damage; and

(c) Except as otherwise provided in subsection 2, not backfill the area around the damaged subsurface installation until the operator of the subsurface installation has had a reasonable amount of time to inspect, maintain and repair the subsurface installation.

2. If the operator of a damaged subsurface installation consents, the excavator may backfill the area around a damaged subsurface installation without the inspection, maintenance or repair of the subsurface installation by the operator.

3. If the damaged subsurface installation presents an emergency, the excavator:

(a) In addition to the notification required pursuant to subsection 1, shall inform all appropriate local public service agencies or, if available, telephone emergency 911 services;

(b) Except as otherwise provided in paragraph (c), shall take reasonable steps to ensure public safety and to minimize the hazard presented by the damaged installation; and

(c) Shall not operate any valve or other device of the operator of the damaged subsurface installation while taking steps to ensure public safety and to minimize the hazard presented by the damaged installation. (Added to NAC by Pub. Utilities Comm'n by R156-03, eff. 8-25-2004)

**NAC 455.165 Period for conducting excavation or demolition: Validity of notification; extension.** (NRS 455.110, 703.025, 704.260, 704.280)

1. A notification submitted by an excavator to an association for operators is valid to conduct an excavation or demolition for 28 calendar days after the date and time that the excavator provided the notification to the association for operators pursuant to the provisions of NRS 455.110.

2. An excavator may submit a request to the association for operators to extend the period for which the excavator may engage in the excavation or demolition by an additional 28 calendar days.

3. At the time the excavator submits a request pursuant to the provisions of subsection 2, the excavator shall inform the association for operators whether an operator with subsurface installations within the affected area of the proposed excavation or demolition needs to make replacement marks identifying the location of a subsurface installation. Excavators requiring replacement marks shall proceed in accordance with NAC 455.135, subsections 3 and 4.

4 The association for operators shall transmit a notification to the operators with subsurface installations within the affected area(s) of the extension of the time for excavation or demolition and the period for which the excavator may engage in the excavation or demolition shall be deemed to be extended for 28 calendar days.

5. An excavator may not request more than two extensions of the period in which the excavator is permitted to engage in an excavation or demolition pursuant to the provisions of this section. If the excavator needs additional time in which to engage in the excavation or demolition beyond the period afforded by the original notification and the two subsequent extensions, the excavator shall submit a new notification to the association for operators pursuant to the provisions of NRS 455.110. (Added to NAC by Pub. Utilities Comm'n by R156-03, eff. 8-25-2004)

Please NOTE the instructions in the next two paragraphs will explain how you can identify changes in the NAC 455 printed in this manual.

SINGLE UNDERLINING indicates portions of text added to the NAC 455 from LCB File No. R153-07 Proposed Regulation of the Public Utility Commission of Nevada Docket 07-06018.

DOUBLE UNDERLINING indicates portions of text added to the NAC 455 from the Public Utility Commission of Nevada Docket 08-01009



**CAUTION!** There are separate regulations in Nevada Law regarding the performance of acts near overhead lines. Please see NRS 455.200 through 455.220 for those regulations.

---

### **Special Note**

The PUCN has adopted new "Call Before You Dig" regulations, which may be found in the Nevada Administrative Code 455 at [www.leg.state.nv.us/NAC/NAC-455.html](http://www.leg.state.nv.us/NAC/NAC-455.html). These regulations are now in effect and include instructions on submitting a complaint for a violation of the "Call Before You Dig" regulations. NAC 455. 200 – 455.450 inclusive, describe the process for filing and resolving informal and formal complaints. You may obtain a copy of the regulations from the PUCN by calling (775) 684-6104, or you may view and download the regulations at the above website.

## **USA North's Nevada Excavation Manual**

**811 / 1-800-227-2600**



**Know what's below.  
Call before you dig.**

**USA North (Underground Service Alert)**

4090 Nelson Avenue, Suite A, Concord, CA. 94520-1232

Administrative: Phone 925-798-9504; Fax 925-798-9506;

Web Page: [www.usanorth.org](http://www.usanorth.org)

This manual is provided to you as a public service by USA North and is dedicated to the safety of our communities in California and Nevada.

**Know what's below.  
Call 2 Working Days To 14 Calendar Days  
Before You Dig in California and Nevada!**

Revised 01/01/09 ©